

Magneto-rheological & Magneto-strictive Materials

Corso Materiali intelligenti e Biomimetici
27/04/2018

ludovica.cacopardo@ing.unipi.it

Magneto-rheological (MR) materials

*When subjected to a magnetic field, the fluid greatly **increases its apparent viscosity**, to the point of becoming a viscoelastic solid.*

So the amount of **dissipated energy of the system is simply controllable** by acting on the coil current and the system can provide semi-active behaviour.



MR materials: composition

Non colloidal mixture of **ferromagnetic particles** *randomly dispersed in oil or water*, plus some *surfactants* useful to avoid the settling of the suspended particles.

MR fluid particles are primarily on the **micrometer-scale** (0.1–10 μm range) and are too dense for Brownian motion to keep them suspended (in the lower density carrier fluid).

On the contrary, ferrofluid particles are primarily nanoparticles that are suspended by Brownian motion and generally will not settle under normal conditions.

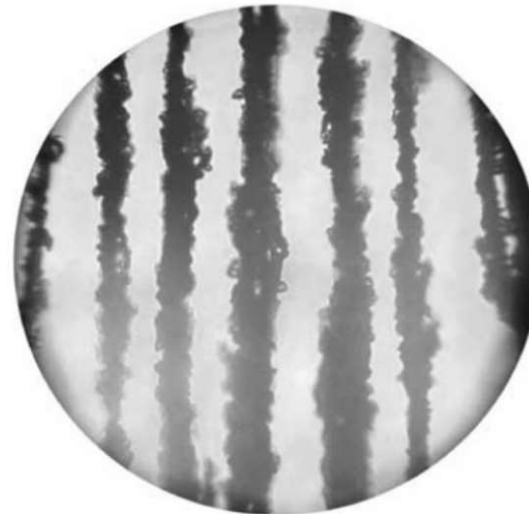
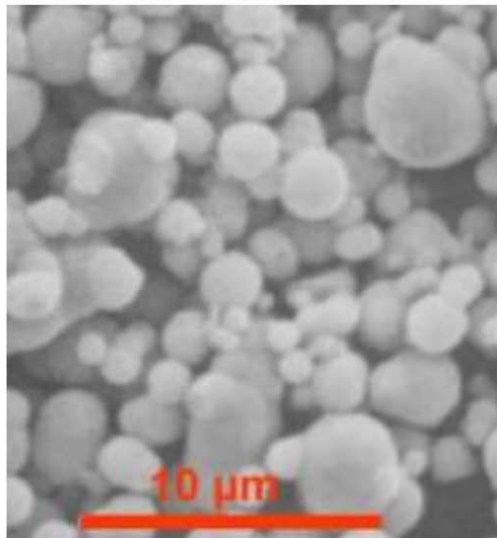

MR materials: behaviour

The ferromagnetic particles feel the induction field and acquire a **magnetic bipole**, then they align themselves along the lines of magnetic flux. *These microscopic chains have a the macroscopic effect to change the apparent viscosity of the fluid.*

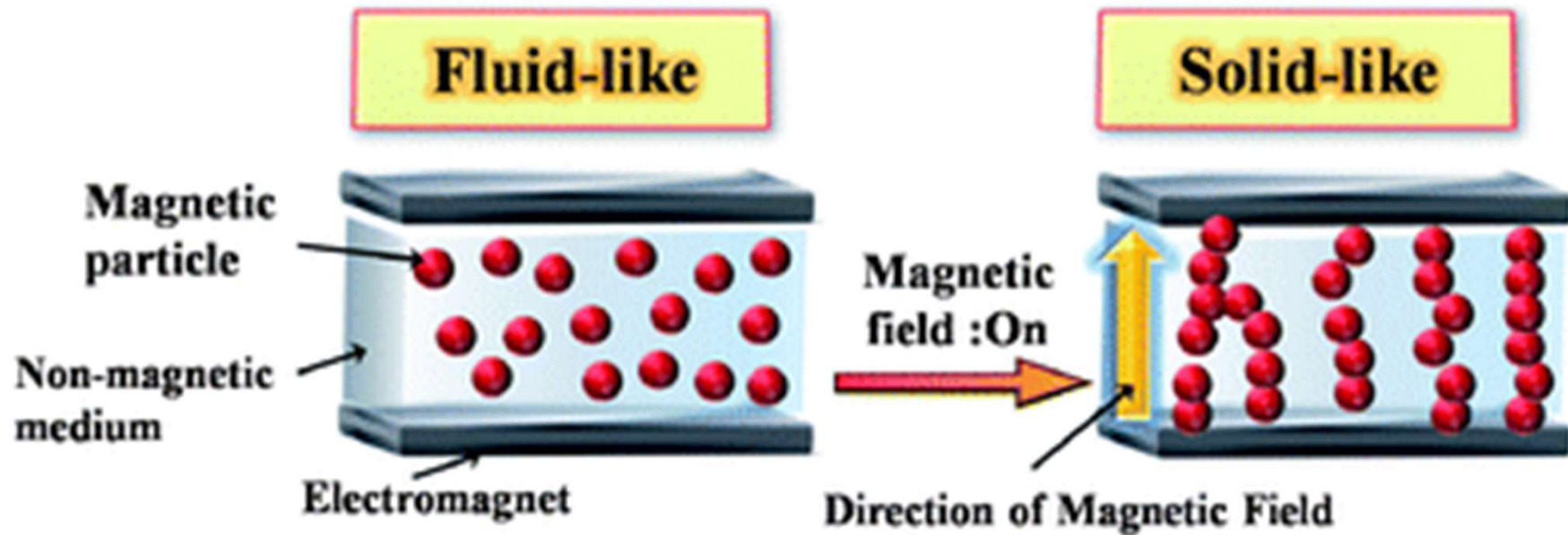

MR materials: properties

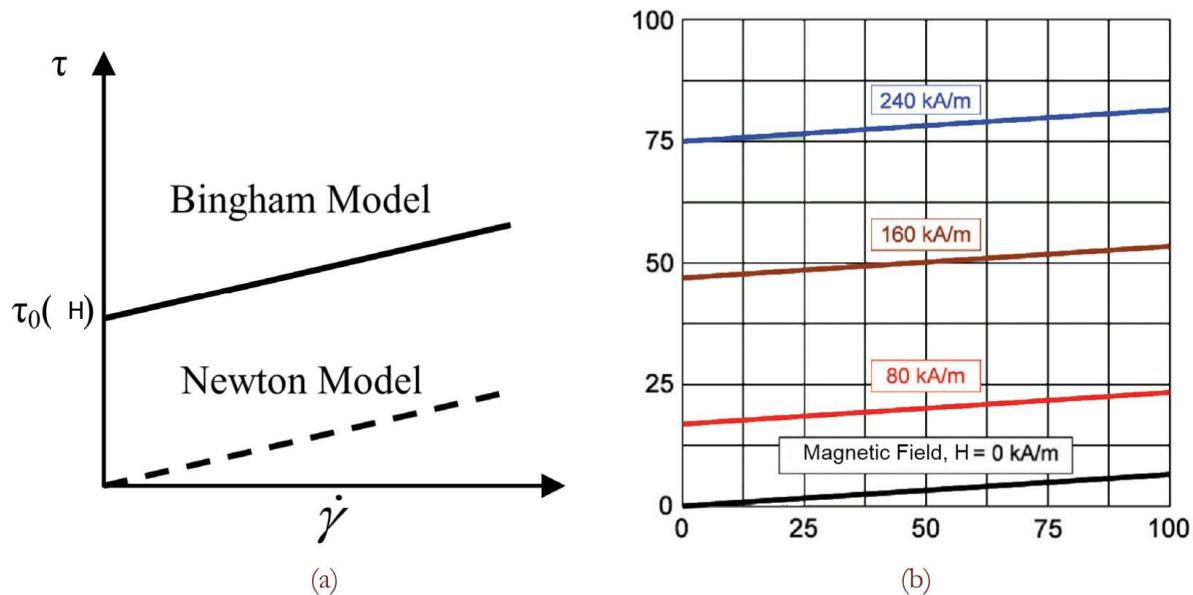

Figure 3: Bingham model of MR fluid (a) and effect of the magnetic field on the yield stress (b).

The **yield shear stress** is the main figure of merit of a MR fluid and derives from the non Newtonian behaviour of these fluids.

The MR fluid behaves following a so called **Bingham** law, which means that it exhibits a *non zero shear stress value for a zero shear rate, behaving more like a solid than like a liquid*. The value of the shear stress at no shear rate is called yield stress of the MR fluid and is controlled by the applied magnetic field.

The larger the field, the higher the yield stress. The higher the yield stress **the higher the force the material can withstand without flowing**.

Bearing a load is possible only because MR fluids can modify their aggregations states changing from a viscous free-flow liquid to a quasi solid state.

Working modes

- a) **Flow mode** exploits the *flow between two fixed walls*, the magnetic field is normal to the flow directions and is typical for *linear damper applications*.
- b) **Shear mode** is mainly used in *rotary application* such as brakes and clutches and the fluid is constrained between two *walls which are in relative motion* with the magnetic field normal to the wall direction.
- c) **Squeeze mode** is used mainly for *bearing applications*, is able to provide *high forces and low displacements* having the magnetic field normal to walls directions.

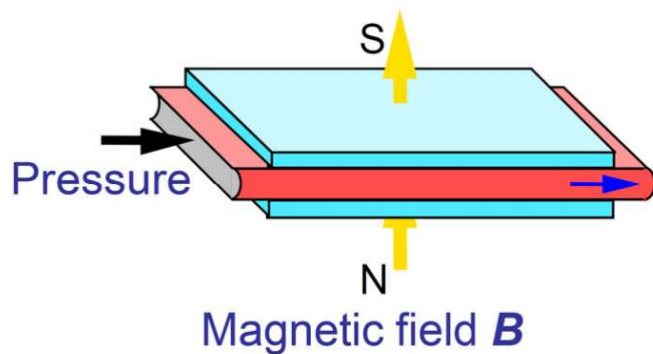

(a)

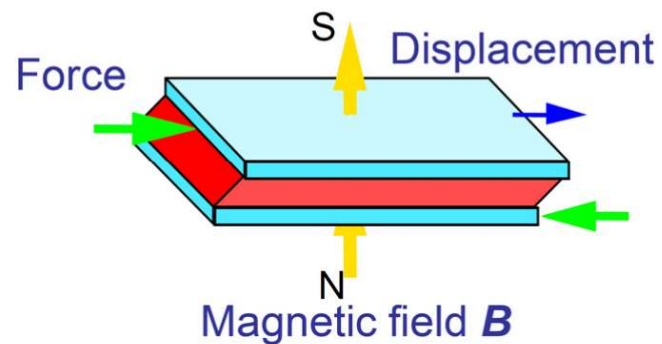

(b)

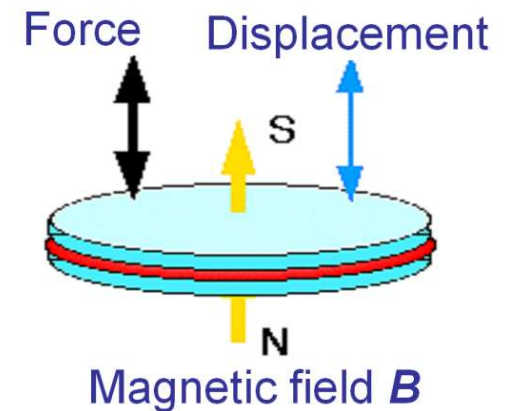

(c)

Lumped parameter model 1

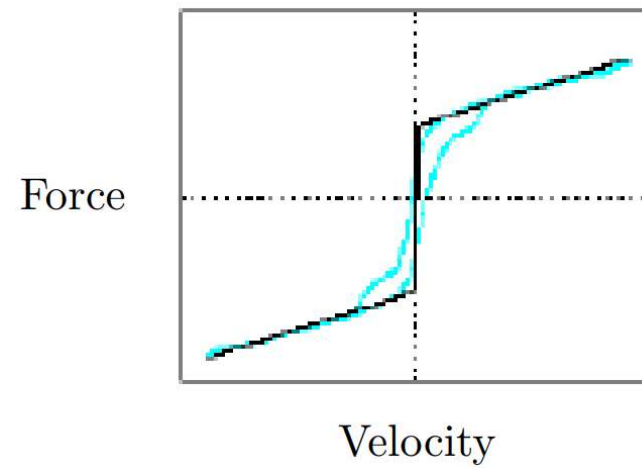
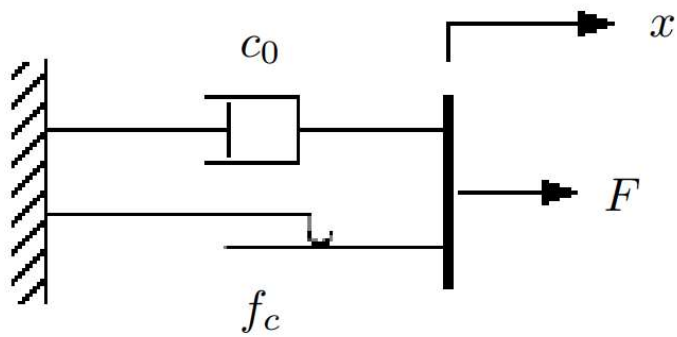

Lumped parameter model 2

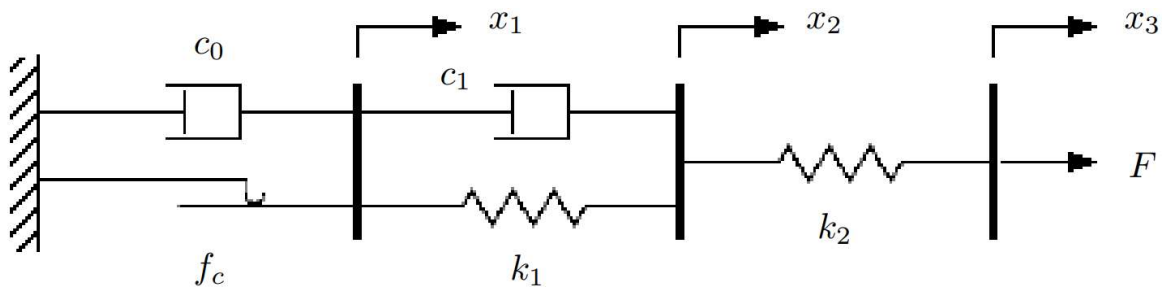

Force

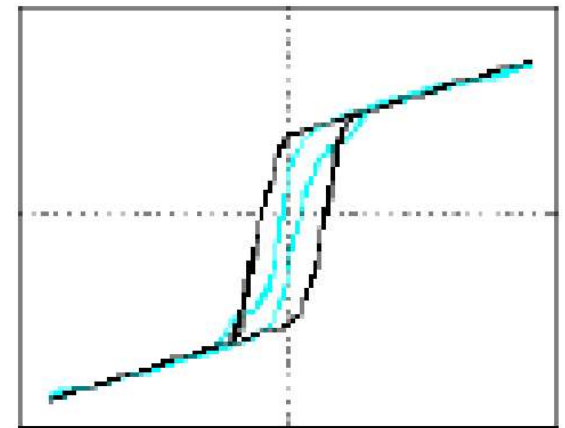

Velocity

Commercial MR & Limitations

MRF COMMERCIALI	PERCENTUAL E IN VOLUME DI PARTICOLATO	MATRICE FLUIDA	DENSITÀ [g/cm ³]
MRX-126PD	26	Olio di idrocarburi	2.66
MRX-140ND	40	Olio di idrocarburi	3.64
MRX-242AS	42	acqua	3.88
MRX-336AG	36	Olio di silicone	3.47

- High density, due to presence of iron, makes them **heavy**. However, *operating volumes are small*, so while this is a problem, it is not insurmountable.
- High-quality fluids are **expensive**.
- Fluids are subject to thickening after prolonged use and need **replacing**.
- **Settling of ferro-particles** can be a problem for some applications.

Example of application: Linear Dampers

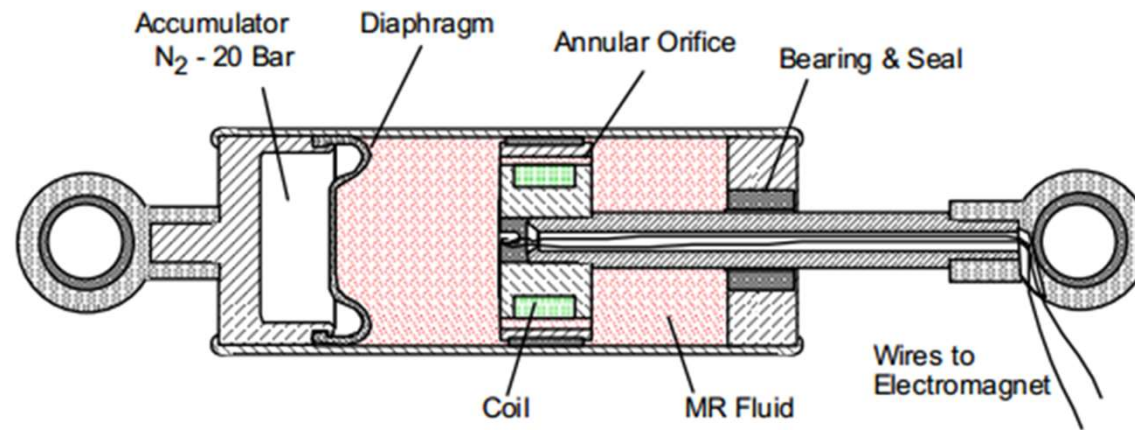

(a) Hardware structure

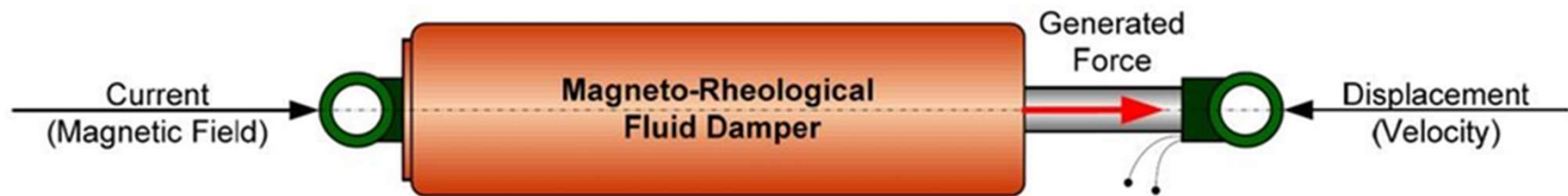

(b) Working principle

Magneto-strictive materials (MS)

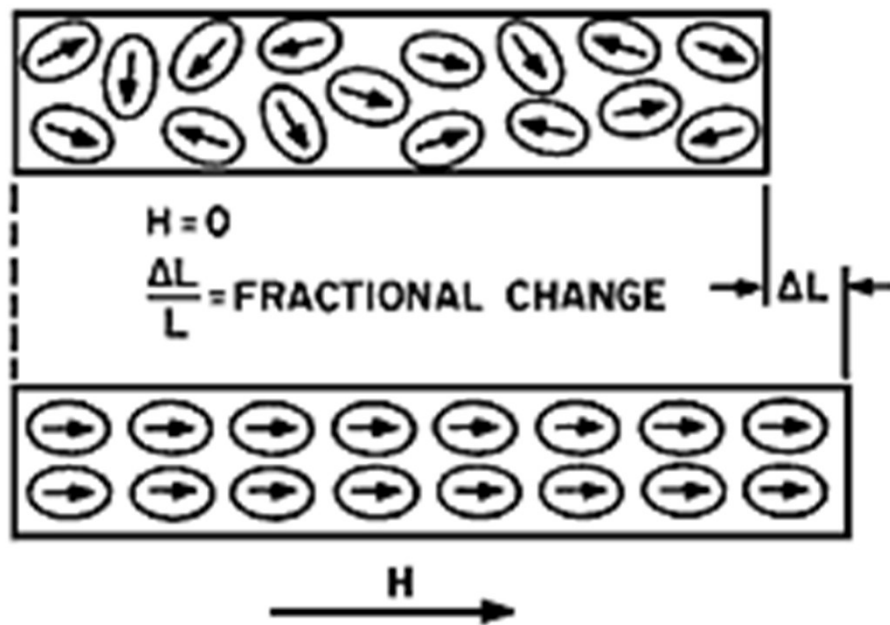

Magnetostriction is a property of ferromagnetic materials that causes them to **change in shape** of materials under the influence of an **external magnetic field**. The cause of magnetostriction change in length is the result of the **rotation of small magnetic domains**.

This rotation and re-orientation causes **internal strains** in the material structure. The strains in the structure lead to the **stretching** (in the case of positive magnetostriction) of the material in the direction of the magnetic field.

Magnetostriction

Internally, ferromagnetic materials have a structure that is divided into **domains**, each of which is a region of uniform magnetic polarization. When a magnetic field is applied, the boundaries between the domains shift and the domains rotate; both of these effects cause a change in the material dimensions.

The reason that a **change in the magnetic domains** of a material results in a **change in the materials dimensions** is a consequence of **magneto-crystalline anisotropy**, that it takes more energy to magnetize a crystalline material in one direction than another. If a magnetic field is applied to the material at an angle to an easy axis of magnetization, the material will tend to rearrange its structure so that an easy axis is aligned with the field to minimize the free energy of the system.

Since **different crystal directions are associated with different lengths** this effect induces a strain in the material.

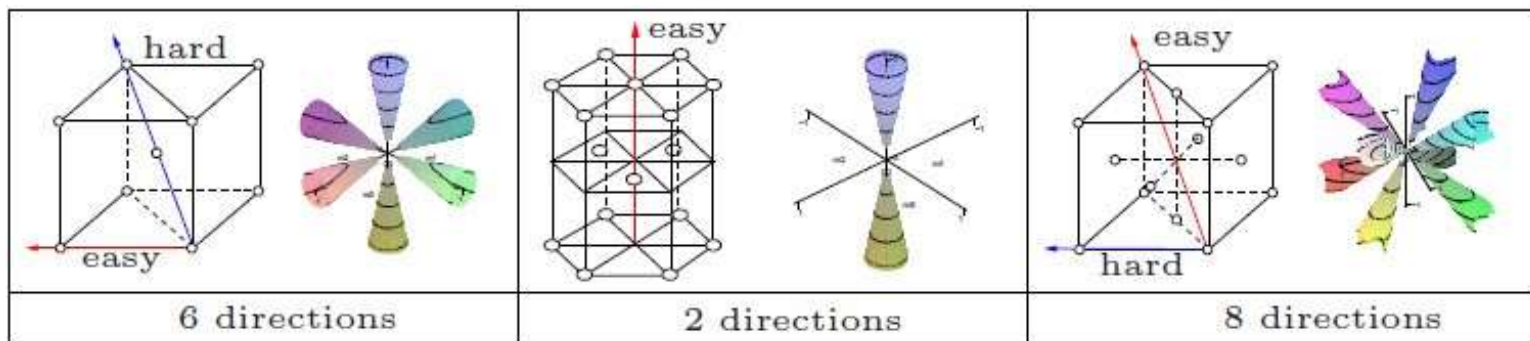

Strain vs. Magnetic field

Applying a stronger field leads to stronger and more definite re-orientation of more and more domains in the direction of magnetic field. When all the magnetic domains have become aligned with the magnetic field **the saturation** point has been achieved.

In the region 1–2 ideally there should be an almost **linear relationship between strain and magnetic field**. Because the relationship is a simple one, it is easier to predict the behaviour of the material and so most devices are designed to operate in this region.

Beyond point 2, the **relationship becomes non-linear** again as a result of the fact that most of the magnetic domains have become aligned with the magnetic field direction. At point 3 there is a **saturation** effect, which prevents further strain increase.

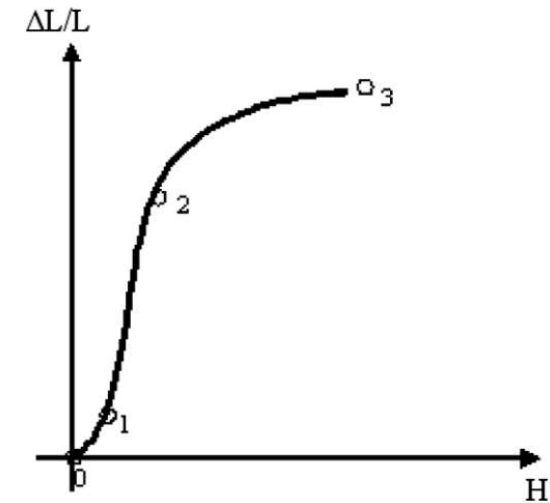

Fig. 1. Strain versus magnetic field.

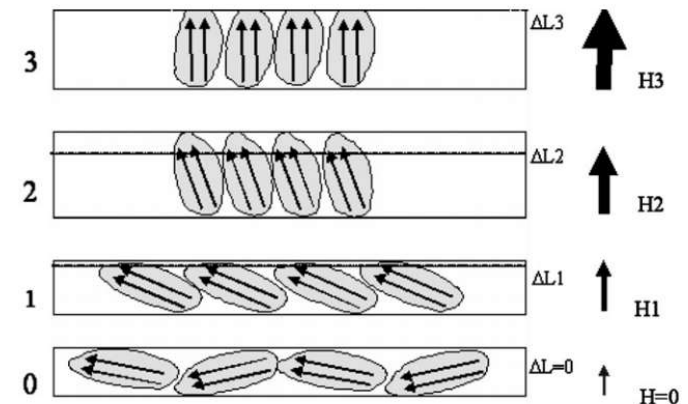

Fig. 2. Strain versus magnetic field, schematically.

Strain vs. Magnetic field (2)

When a magnetic field is established in the opposite direction, the negative field produces the same elongation in the magnetostrictive material, as a positive field would. The shape of the curve is reminiscent of a butterfly and so the curves are referred as **butterfly curves**.

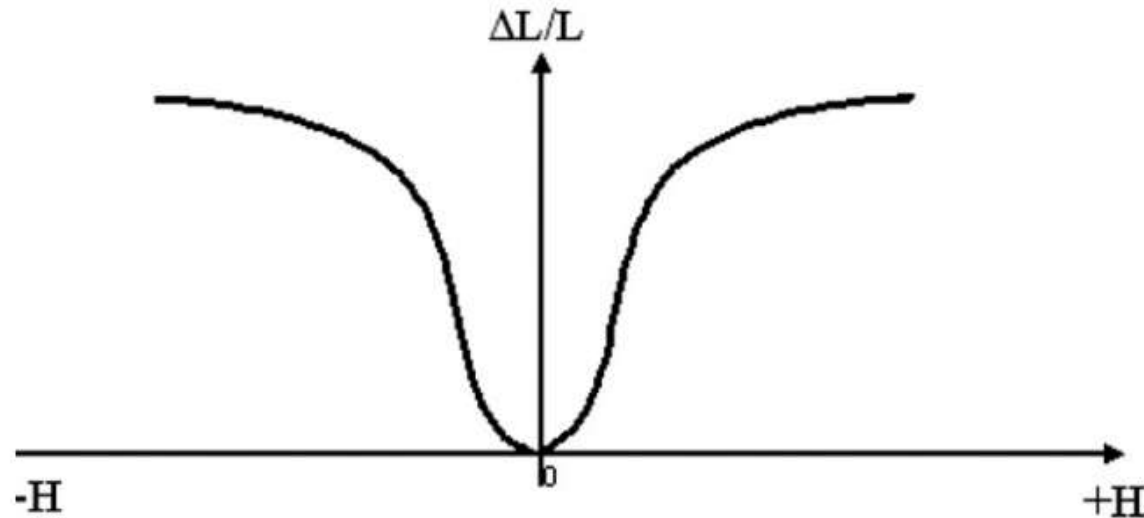

Fig. 3. Strain versus symmetric magnetic field.

(Main) Magnetostrictive Effects

Magnetostriction is, in general, a reversible exchange of energy between the mechanical form and the magnetic form.

The **Joule Effect** consist in the **expansion, positive magnetostriction, or contraction, negative magnetostriction**, of the material.

In the absence of the magnetic field, the sample shape returns to its original dimensions.

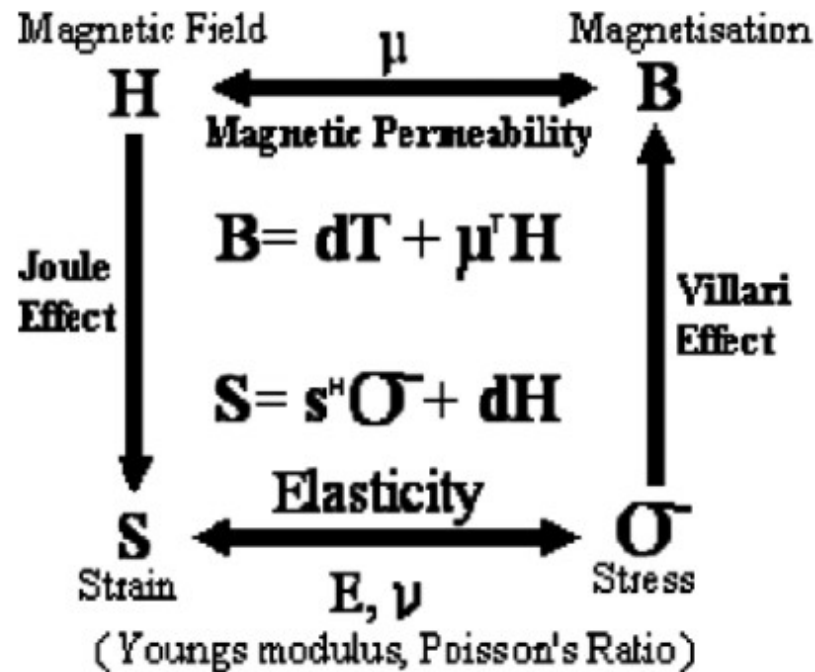

The **Villari Effect** is a **change of the magnetic susceptibility** (response to an applied field) of a material when **subjected to a mechanical stress**.

There is a change in the magnetic flux density which flows through the sample as a result of the creation of a magnetic field. The change in flux density can be detected by a pickup coil and is proportional to the level of the applied stress.

$$V = -NA \frac{dB}{dt}$$

Example of MS materials

- **Cobalt** exhibits a room-temperature magnetostriction of *60 microstrains*.
- Cobalt alloys: **Terfenol-D**, (Ter for terbium, Fe for iron, NOL for Naval Ordnance Laboratory, and D for dysprosium) exhibits about *2000 microstrains* in a field of 160 kA/m at room temperature and is the most commonly used engineering magnetostrictive material.
- **Metglas** 2605SC (amorphous alloy $\text{Fe}_{81}\text{Si}_{3.5}\text{B}_{13.5}\text{C}_2$). Favourable properties of this material are its *high saturation-magnetostriction constant, λ* , of about *20 microstrains* and more, coupled with a low magnetic-anisotropy field strength, H_A , of less than *1 kA/m* (to reach magnetic saturation).



MS properties

Table 1
Technology features overview [1,2,8–11]

Typical features	PZT	Terfenol-D	SMA
Actuation mechanism	Piezoelectric material	Magnetostrictive material	Shape memory alloys
Elongation	0.1%	0.2%	5%
Energy density	2.5 kJ/m ³	20 J/m ³	1 J/m ³ *
Bandwidth	100 kHz	10 kHz	0.5 kHz
Hysteresis	10%	2%	30%
Costs as reference	200 \$/cm ³	400 \$/cm ³	200 \$/cm ³

Application example: MS actuator

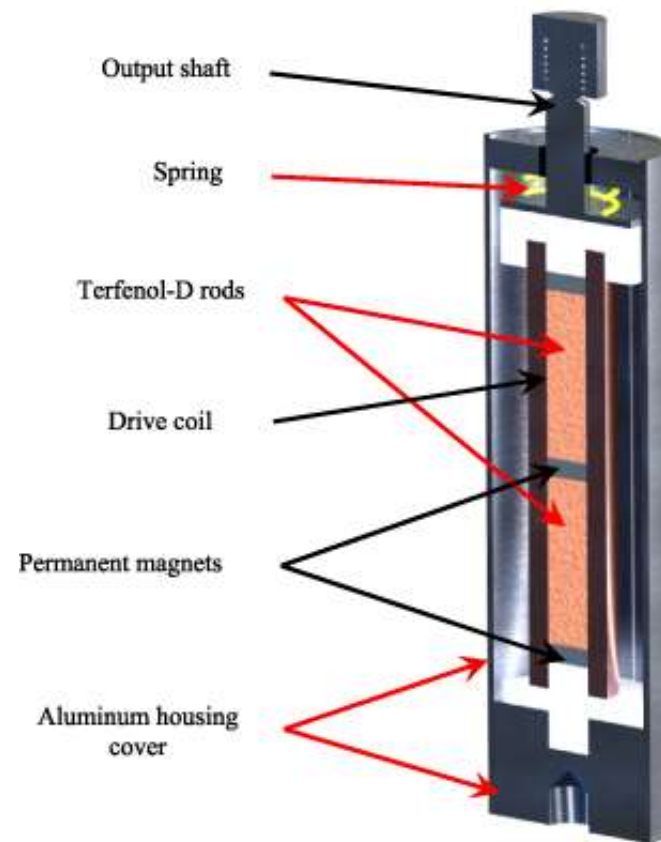

Application example(2): MS inchworm motor

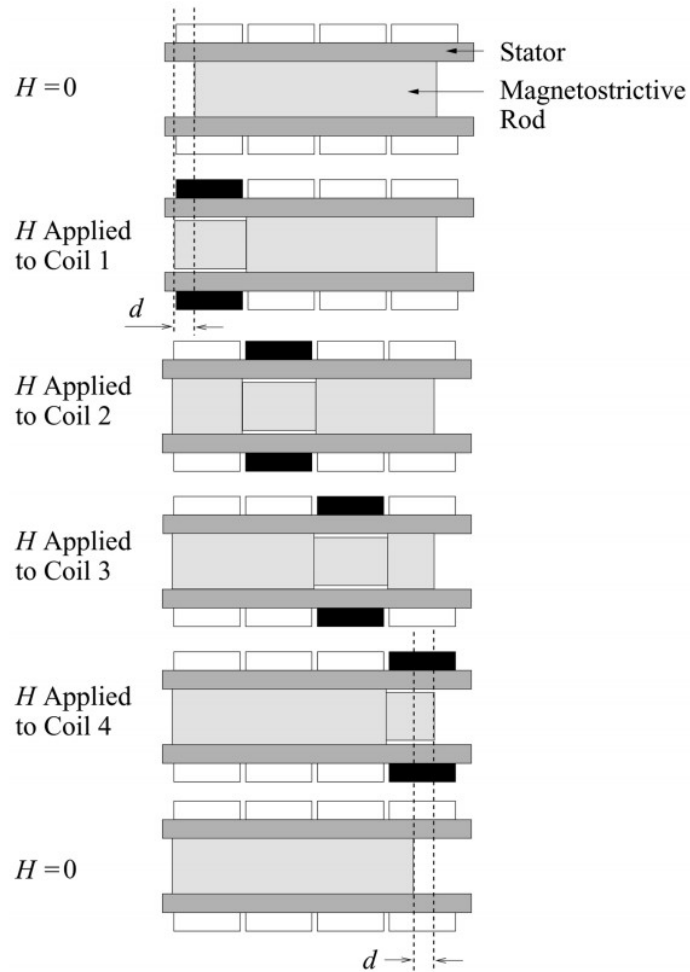

When one of the coils is energized, the section of rod directly exposed to the magnetic field **elongates and shrinks.**

As the field is removed, the **rod clamps itself again inside the stator** but at a distance d to the left of the original position.

As the remaining coils are energized sequentially and the magnetic field profile is swept, *the rod moves in the direction opposite to the sweeping field.* The direction of motion is changed by inverting the sequence in which the coils are energized.